

RING FRAME

3700

KEEP THIS DOCUMENT



Warning:

This equipment should be installed by a qualified individual.

The apparatus should be used by only one person at a time, supervised by a qualified individual and with appropriate landing mats or a landing pit.

Using this equipment for purposes other than those originally intended is not allowed.

Compliance:

This equipment complies with the requirements of the European standards EN 913 "Gymnastic equipment - General safety requirements and test methods" and EN 12655 "Gymnastic equipment – Rings – Safety requirements and test methods".

This equipment is F.I.G. approved.

Recommendations:

As shown in French Standard NF S52-400 the following is recommended:

- keep these instructions for subsequent reference (inspection, maintenance, etc.).
- periodically carry out predictive maintenance.
- depending on how much it is used, have the equipment serviced yearly or every few years.

Weight of the apparatus:

Ref. : 3700 —> 79 kg (174.17 lb)

Overall size:

- Apparatus without cabling: 2.70 x 0.10 m (106.30 x 3.94 in)
- Apparatus with standard cabling: 5.50 x 4.00 m (216.54 x 157.48 in)

Frame height:

- Maximum frame height: 6.05 m (238.19 in)

Packaging:

Ref. / Package	370/04 Pair of Lower uprights	370/07 Pair of Upper uprights	370/06 Ring Frame Head	3730 Pair of rings + straps + cabling	3770/10 Ring frame bracing cables	No. of Packages
3700 Ring frame	1	1	1	1	1	5
Volume (ft³)	1.939	1.515	3.440	0.434	0.848	X
Weight (lb)	59.52	63.93	17.64	4.41	28.66	
Dimensions (in)	120.08 x 7.09 x 3.94	111.02 x 7.48 x 3.15	65.75 x 20.87 x 4.33	14.17 x 12.20 x 4.33	15.75 x 11.81 x 7.87	

I. Preparing the cables:

Refer to the Assembly Instructions NM181.

II. Assembling the apparatus (minimum of six people required) (see Fig. 1):

Note: Prepare a clean area for assembling the apparatus.

- 1 - Lay both lower uprights (3) parallel on the floor.
- 2 - Fit the upper uprights (4) onto the lower uprights (3).
- 3 - Fit the frame head (5), on each side, onto the lower upright (3) + upper upright (4) assemblies.
- 4 - Install the rings (6) on the frame head (5): insert each swivel pin screw (8) through the frame head (5), firmly tighten the nuts (11).
- 5 - In order to obtain the 2.80 m prescribed height for the rings (6) with regard to the floor, install the attachment elements (9) + (10) at the bottom of uprights (3) into the 5th hole of the sliding tubes (1).
Moderately lock the attachment elements (9) + (10).
- 6 - Install the pivots (12) into their housings on the floor (if required), in line with the plotting.

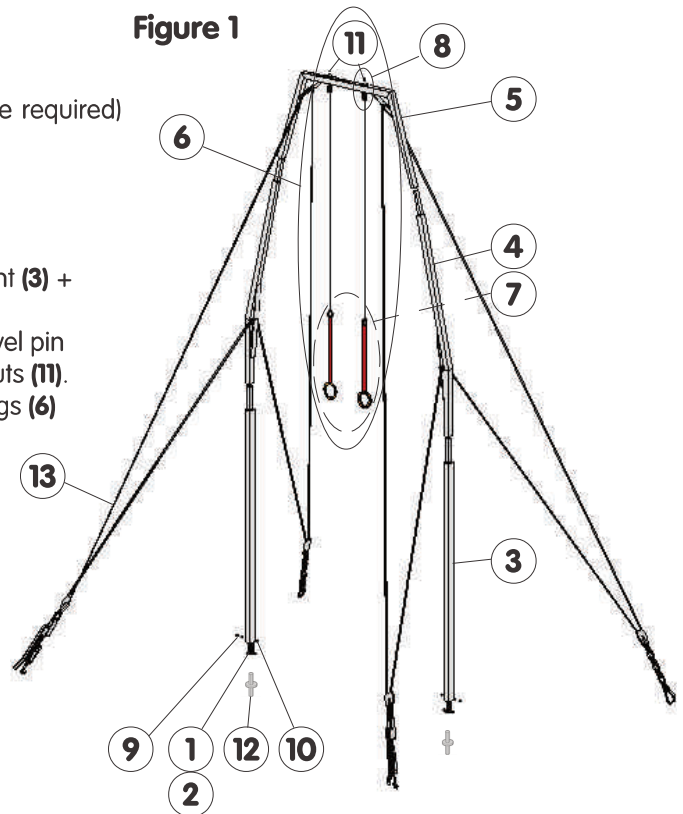

III. Assembling, adjusting and tightening the cables:

Important: When the vertical position of the frame is adjusted, and before tightening the cables (13), do not forget to lock all the attachment elements on floor.

Refer to the Assembly Instructions NM181.

IV. Adjusting the height (see Fig. 1):

- 1 - Loosen the cables (13) using the quick tighteners (see NM181).
 - 2 - Slightly lift the upright (3) to remove the attachments (9) + (10) at the bottom of the uprights (3).
 - 3 - Raise or lower the uprights (3) until the bar is at the desired height.
 - 4 - Install the attachment elements (9) + (10) at the bottom of the uprights (3) into the hole of the sliding tubes (1) corresponding to the desired height. Moderately lock the attachment elements (9) + (10).
- Important:** Check that both sliding tubes (1) are adjusted to the same height - this is mandatory.
- 5 - Retighten the cables (13).

V. Adjustment values (see Fig. 2):

Ring height:	1st hole = 2.60 m	2nd hole = 2.65 m	3rd hole = 2.70 m
	4th hole = 2.75 m	5th hole (F.I.G.): = 2.80 m	6th hole = 2.85 m
	7th hole = 2.90 m	8th hole = 2.95 m	

Figure 2

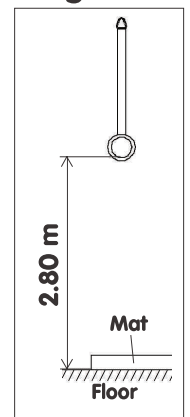

VI. Maintenance:

- 1 - A regular cleaning of the apparatus allows better viewing of the problems, if any (distortion, breakage, or corrosion).
- 2 - Before use, check wear parts and safety elements each time for good condition and operation:
 - pads (2),
 - all the bracing cable elements (cables, tighteners, quick links locked, etc.).
 - complete rings (6): cables (no shredded), straps (no cut seams), and swivel pins (tightened). We recommend to change them regularly as required by usage frequency (at least every 3 years).
- 3 - Check the tightening of cables (13) and closure of quick links, ... (see NM181), before each use.
- 4 - Check the correct tightening of all attachment elements (9) + (10) + (11) and the locking of anchors.
- 5 - **Important:**
 - If a problem is detected or suspected, do not use the equipment as long as it has not been checked by a technician.
 - Any damaged or distorted piece should be replaced as soon as possible.

V. Storage:

Always store the equipment away from humidity and heat.

ITEM	QTY	DESCRIPTION	REFERENCE	REMARKS
30	-			
29	-			
28	-			
27	-			
26	-			
25	-			
24	-			
23	-			
22	-			
21	-			
20	-			
19	-			
18	-			
17	-			
16	-			
15	-			
14	1	Handling pole for rings	3785	spare kit
13	-	Frame cabling	3700/10	pack
12	2	Support pivot	328/02	included in 11
11	2	M14 H locknut	VEHF14000Z	-
10	2	M10 H knurl nut	VEML10350Z	-
9	2	M10x70 H screw	VH0010070Z	-
8	2	Swivel pin of Ring	373/11	included in 6
7	1	Pair of rings + straps	3720	included in 6
6	1	Pair of rings + cables	3730	pack
5	1	Frame head	370/06	pack
4	1	Pair of upper uprights	370/07	pack
3	1	Pair of lower uprights	370/04	pack
2	2	Frame pad	370/05	included in 3
1	2	Frame sliding tube	-	included in 3
ITEM	QTY	DESCRIPTION	REFERENCE	REMARKS



RUE GASTON DE FLOTTE
13012 MARSEILLE
Tel. : 33-(0)-4-91-87-51-20
Fax : 33-(0)-4-91-93-86-89

BY : J.GAULTIER

DATE: 29/11/06

NW91

Ref. : 3700

RING FRAME

THIS DOCUMENT IS THE PROPERTY OF GYMNNOVA. IT IS CONFIDENTIAL AND SHALL NOT BE REPRODUCED WITHOUT PRIOR AUTHORIZATION

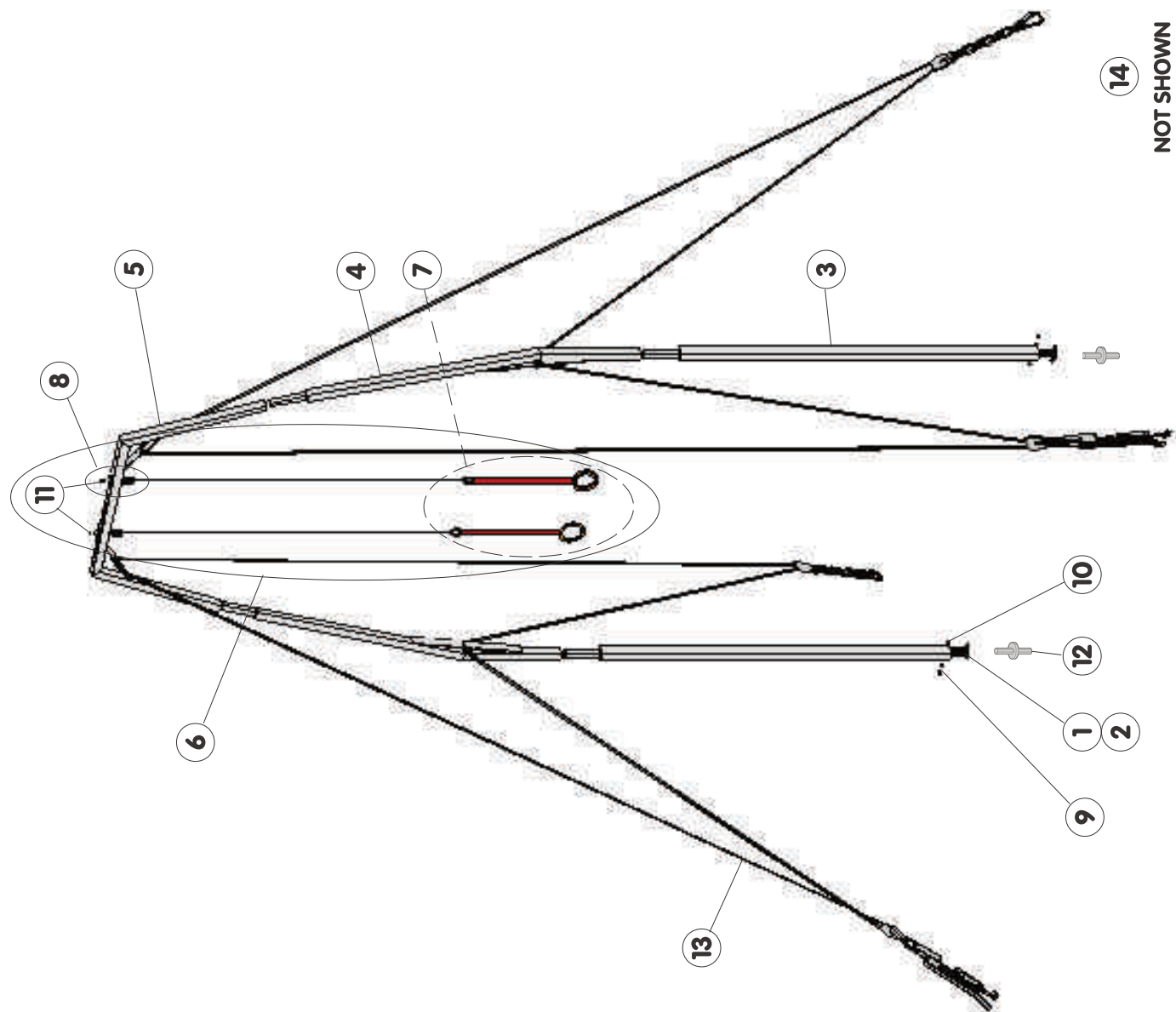

To order spare parts, provide the description, part no., and delivery date of the entire apparatus.

**STANDARD CABLING M'2009
FOR RING FRAMES****3700/40****KEEP THIS
DOCUMENT**

Ref. : 3700C

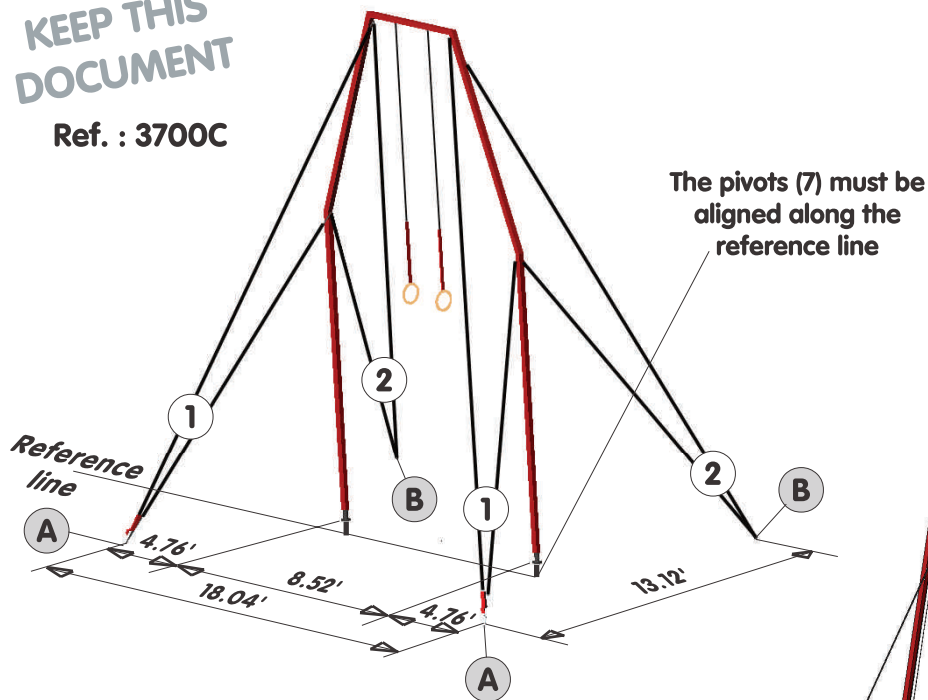

The spacing cable (10)
or the pivots (7)
should be in line with
the reference line

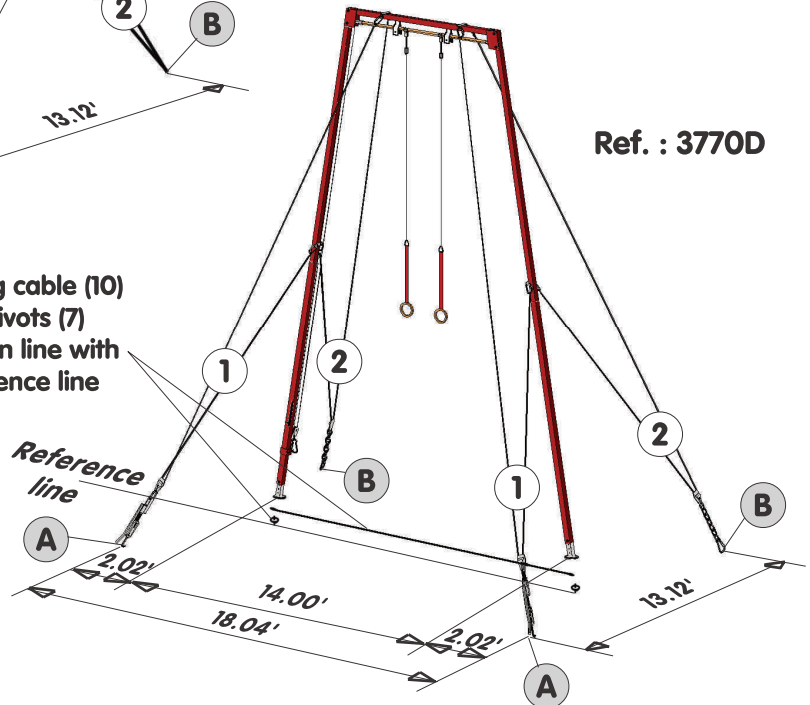

Ref. : 3770D

Warning:

This equipment should be installed by a qualified individual.

The apparatus should only be used by one person at a time, under the supervision of a qualified individual.

Using this equipment for purposes other than those originally intended is not allowed.

Attachments that are not provided with the apparatus may only be used if the support complies with the **CC34** specifications for GYMNOVA chemical anchors, (ref. : 2005 or ref. : 2010) or **CC22** for GYMNOVA retractable anchors, (ref. : 2000/40 - 2000/80).

Make sure that the quick links are closed and anchors are tightened before tightening the cables.

Do not use the equipment when the cables are slack.

Compliance:

This equipment complies with the requirements of the European standard EN 913 "Gymnastic equipment - General safety requirements and test methods".

Recommendations:

As shown in French Standard NF S52-400 the following is recommended:

- keep these instructions for subsequent reference (inspection, maintenance, etc.).
- periodically carry out predictive maintenance.
- depending on how much it is used, have the equipment serviced yearly or every few years.

Packaging:

1 Pack (ref.: 3700/40)

Dimensions: 400 x 300 x 220 mm (15.75 x 11.81 x 8.66 in)

Weight: 17 kg (37.5 lb) Volume: 0.0264 m³ (0.93 ft³)

I. Preparing the cables:

1 - Floor positioning (see Fig. 1, Fig. 2, Fig. 3 and Fig. 4):

- Plot the floor positioning of the anchors and distances between legs.
- Drill in accordance with the assembly instructions **NM13** for chemical anchors or **NM25** for retractable anchors (for pivots **(7)**: drill $\varnothing 12,45$ mm (1.77 in) deep, if required).

- Important:**
- The cable attachment points must resist 800 daN (see: NF S52-400).
 - It is mandatory that the uprights are aligned with the reference line.

Figure 1

Layout checking dimension:
22.31 ft diagonal

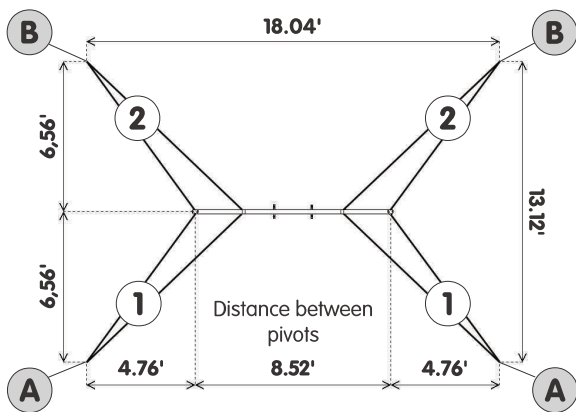

Ref. : 3700C

Figure 2

Layout checking dimension:
22.31 ft diagonal

Layouts
F.I.G.

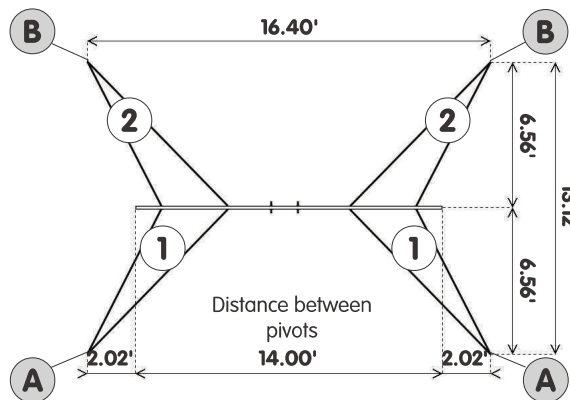

Ref. : 3770D

Figure 3

Layout checking dimension:
22.31 ft diagonal

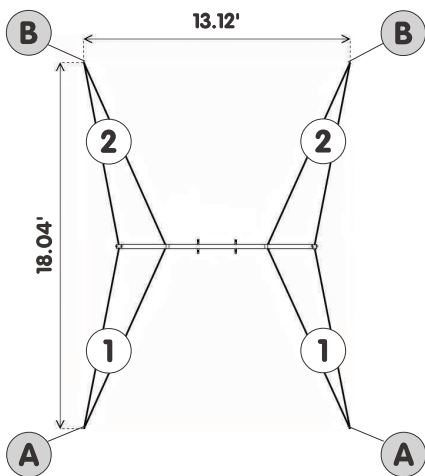

Other possible
layouts

Figure 4

Layout checking dimension:
16.40 ft diagonal

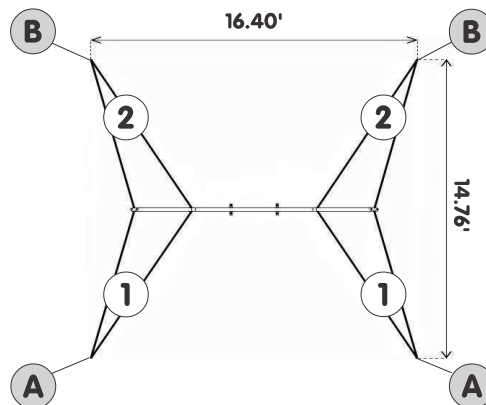

2 - Layout of cabling items:

TO FLOOR
(ANCHORS)

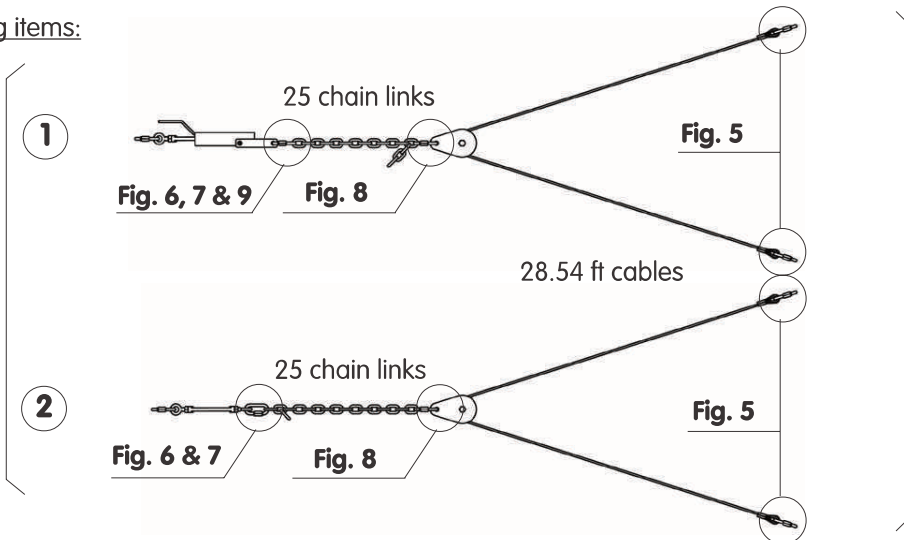

TO
UPRIGHTS

3 - Assembly principle and precautions:

- Make sure you assemble the quick links (3) in the proper direction (always tighten downward) (see Fig. 5).
- Adjust the turnbuckles (5) to medium length to enable the cables to be adjusted easily.

Note: Do not lock the floor attachments so that the bracing flats (8) can be positioned.

Figure 5 - Quick link (3) – assembling direction

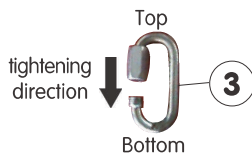

Figure 8 - Chain + quick link (3) /pulley (6)

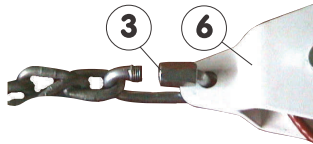
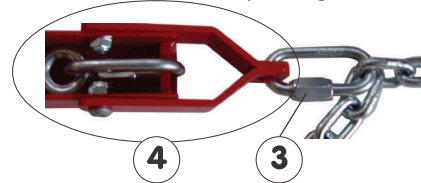

Figure 6 & 7 - Quick link (3) / chain assembly



Figure 9 - Quick link (3) / quick tightener (4)



II. Assembling the cables (minimum of 6 people required):

- Identify the location of each cable using **Figures 1, 2, 3 and 4** (on page 2) and overview (on 1st page).
- Once the respective position of the cables is determined, attach one end of each cable at mid-height of the frame (uprights), and the other end at the top of the frame (head of 3770D and uprights of 3700C), observing the assembly direction of the quick links (3) (see **Fig. 5**).
- Hook the cables (2) to the rear anchors (B) using the turnbuckles (5).
- Lift the frame and position it over the reference line or into the pivots (7).
- Hold the frame and hook the cables (1) to the front anchors (A) using the open quick tighteners (4).
- Set the frame assembly vertical (use a level) by adjusting the chain links, then fine-tune the adjustments using the turnbuckles (5) of cables (1) and (2).

III. Adjusting and tightening the cables:

Important: Remember to lock all the floor attachments (9) before tightening the cables.

- 1 - To fine-tune the tension of cables (1), open the quick tightener (4) (see **Fig. 11**), screw or unscrew the turnbuckle (5). Lock the locknuts, then close the quick tightener (see **Fig. 10**).
- 2 - Position the quick tightener (4) so that it is above the turnbuckle (5).
- 3 - **Important:** Lock the quick links (3) and the locknuts on turnbuckles (4) and (5) using the wrench.

Figure 10 - Slack cabling: Open quick tightener

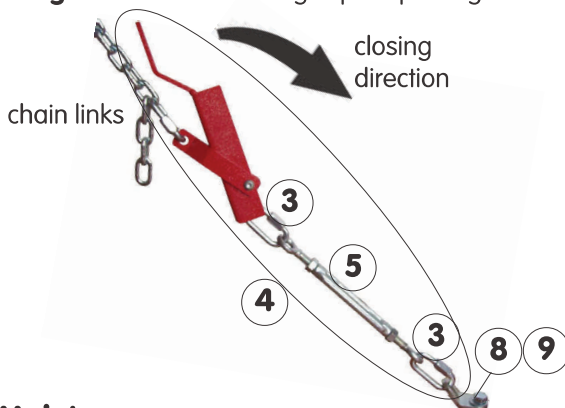
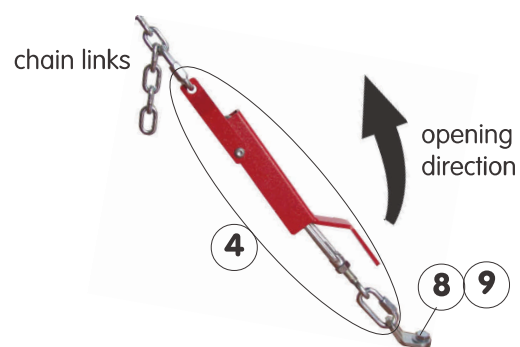

Figure 11 - Tightened cabling: Closed quick tightener



IV. Maintenance:

- 1 - A regular cleaning of the apparatus allows better viewing of the problems, if any (distortion, breakage, or corrosion).
- 2 - Before use, thoroughly check wear parts and safety elements each time for good condition and operation: wear of cables, quick links (3), chain links, bracing flats (8), quick tighteners (4), the turnbuckles (5) and pulleys (6).
- 3 - Check the tightening of cables and closure of quick links, before each use.
- 4 - Check that the anchors (9) are locked and that they do not draw out from the floor.
- 5 - Make sure pulleys are not jammed.
- 6 - **Important:**
 - If a problem is detected or suspected, do not use the equipment as long as it has not been checked by a technician.
 - Any damaged or distorted piece should be replaced as soon as possible.

V. Storage:

Always store the equipment away from humidity and heat.

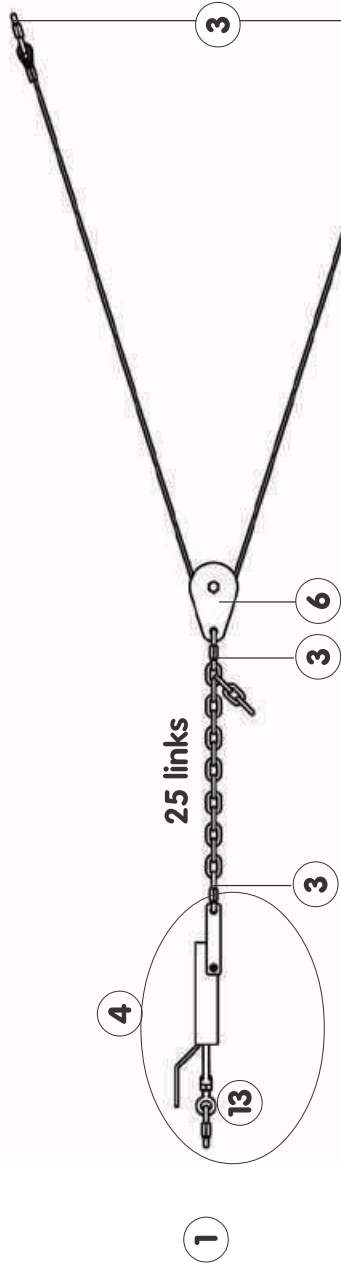

Cables: 28.54 ft

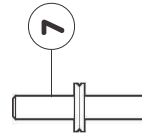
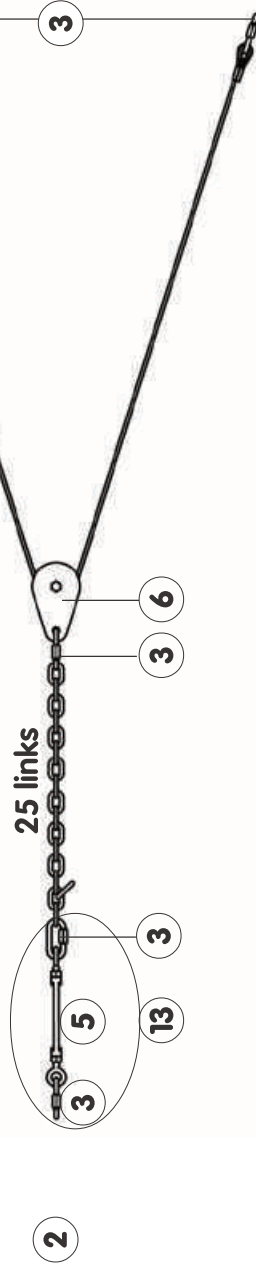

10 11 12

NOT SHOWN

ITEM	QTY	DESCRIPTION	REFERENCE	REMARKS
29	-		-	-
28	-		-	-
27	-		-	-
26	-		-	-
25	-		-	-
24	-		-	-
23	-		-	-
22	-		-	-
21	-		-	-
20	-		-	-
19	-		-	-
18	-		-	-
17	-		-	-
16	-		-	-
15	-		-	-
14	-		-	-
13	4	M12 Turnbuckle + Quick link	QTELEMA812	each
12	-	Share of 4 brac. flats+screws	3120/40	spare kit
11	-	Share of 2 brac. flats+screws	3120/20	spare kit
10	1	M'2000 spacing cable	3770/05	not provided
9	-	4 retractable anchors	2000/40	not provided
9	-	4 chemical anchors	2010	not provided
8	4	Bracing flat	-	not provided
7	2	Support pivot	328/02	each
6	4	Single pulley, ø80	371/21	each
5	4	Turnbuckle M12 O/O	QTELE1012G	each
4	2	Quick tightener	2550A	spare kit
3	18	Quick link No.8	QMRA00008Z	-
2	2	Cable + turnbuckle	3700/41	spare kit
1	2	Cable + quick tightener	3700/42	spare kit

Gymnova
 RUE GASTON DE FLOTTE
 13012 MARSEILLE
 Tél. : 33-(0)-4-91-87-51-20
 Fax : 33-(0)-4-91-93-86-89

**STANDARD CABLING M'2009
 FOR RING FRAMES**

To order spare parts, provide the description, part no., and delivery date of the entire apparatus.